

DS-2SE4C425MWG-E/RB/14**TandemVu 4+4MP 25X ColorVu & IR Acusense Network Speed Dome with R/B Strobes**

Hikvision DS-2SE4C425MWG-E(14F0) 4 MP 25 × IR Network Speed Dome adopts 1/2.8" progressive scan CMOS chip. With the 15 × optical zoom lens, the camera offers more details over expansive areas.

This series of cameras can be widely used for wide ranges of high-definition, such as rivers, roads, railways, airports, squares, parks, scenic spots, and venues, etc.

- Captures a large area and great details at the same time
- High quality imaging with 4 MP resolution
- Focuses on human and vehicle targets classification based on deep learning
- Excellent low-light performance with powered-by-DarkFighter technology and ColorVu technology
- Secures an expansive area with 25 × optical zoom and 16 × digital zoom
- Expansive night view with up to 100 m IR distance & 30 m white light
- Build-in speaker and dual-microphone for real-time high quality audio security
- Active red and blue strobe light and audio alarm to warn intruders off
- Supports 12 VDC & PoE+

▪ Specification

| Camera | |
|------------------------|---|
| Image Sensor | [Bullet channel] 1/2.8" Progressive Scan CMOS, [PTZ channel] 1/2.8" Progressive Scan CMOS |
| Max. Resolution | [Bullet channel] 2560 × 1440, [PTZ channel] 2560 × 1440 |
| Min. Illumination | [Bullet channel]: 0.0005 Lux @ (F1.0, AGC ON), 0 Lux with light; [PTZ channel]: Color: 0.005 Lux @ (F1.6, AGC ON), B/W: 0.001 Lux @ (F1.6, AGC ON), 0 Lux with IR |
| Shutter Speed | 1 s to 1/30,000 s |
| Day & Night | ICR |
| Zoom | [PTZ channel] 25 × optical, 16 × digital |
| Slow Shutter | yes |
| Lens | |
| Focal Length | [Bullet channel] 2.8 mm, [PTZ channel] 5 to 125 mm |
| FOV | [Bullet channel] horizontal field of view: 96.1°, vertical field of view: 52.1°, diagonal field of view: 113.3°, [PTZ channel] horizontal field of view: 55° to 2.4°, vertical field of view: 33° to 1.4°, diagonal field of view: 61.5° to 2.8° |
| Focus | auto, manual, semi-auto |
| Aperture | [Bullet channel]: F1.0; [PTZ channel]: F1.6 |
| Zoom Speed | [PTZ channel]: approx. 2.3 s |
| Illuminator | |
| Supplement Light Type | [PTZ channel]: IR; [Bullet channel]: White Light |
| Supplement Light Range | [PTZ channel]: up to 100 m; [Bullet channel]: up to 30 m |
| Smart Supplement Light | Yes |
| PTZ | |
| Movement Range (Pan) | 360° endless |
| Movement Range (Tilt) | [Bullet channel] 9° to 21° (manually adjust), [PTZ channel] -15° to 90° |
| Pan Speed | Pan speed: configurable from 0.1° to 80°/s, preset speed: 80°/s |
| Tilt Speed | Tilt speed: configurable from 0.1° to 80°/s, preset speed 80°/s |
| Proportional Pan | yes |
| Presets | 300 |
| Preset Freezing | yes |
| Patrol Scan | 8 patrols, up to 32 presets for each patrol |
| Pattern Scan | 4 pattern scans |
| Park Action | preset, frame scan, tilt scan, patrol scan, random scan, auto scan, pattern scan, panorama scan |
| 3D Positioning | yes |
| PTZ Status Display | yes |
| Scheduled Task | Preset, pattern scan, patrol scan, tilt scan, auto scan, random scan, frame scan, panorama scan, dome reboot, dome adjust, aux output |
| Power-off Memory | yes |
| Video | |
| Main Stream | [Bullet channel] 50 Hz: 25 fps (2560 × 1440, 1920 × 1080, 1280 × 960, 1280 × 720), 60 Hz: 30 fps (2560 × 1440, 1920 × 1080, 1280 × 960, 1280 × 720), [PTZ channel] 50 Hz: 25 fps (2560 × 1440, 1920 × 1080, 1280 × 960, 1280 × 720), 60 Hz: 30 fps (2560 × 1440, 1920 × 1080, 1280 × 960, 1280 × 720) |

| | |
|-----------------------------|---|
| Sub-Stream | [Bullet channel]: 50 Hz: 25 fps (704 × 576, 640 × 480, 352 × 288) 60 Hz: 30 fps (704 × 480, 640 × 480, 352 × 240) [PTZ channel]: 50 Hz: 25 fps (704 × 576, 640 × 480, 352 × 288) 60 Hz: 30 fps (704 × 480, 640 × 480, 352 × 240) |
| Third Stream | [Bullet channel]: 50 Hz: 25 fps (1920 × 1080, 1280 × 960, 1280 × 720, 704 × 576, 640 × 480, 352 × 288) 60 Hz: 30 fps (1920 × 1080, 1280 × 960, 1280 × 720, 704 × 480, 640 × 480, 352 × 240) [PTZ channel]: 50 Hz: 25 fps (1920 × 1080, 1280 × 960, 1280 × 720, 704 × 576, 640 × 480, 352 × 288) 60 Hz: 30 fps (1920 × 1080, 1280 × 960, 1280 × 720, 704 × 480, 640 × 480, 352 × 240) |
| Video Compression | H.265,H.264,MJPEG |
| Video Bit Rate | 32 kbps to 16384 kbps |
| H.264 Type | main profile,baseline profile,high profile |
| H.265 Type | main profile |
| Scalable Video Coding (SVC) | yes |
| Region of Interest (ROI) | 8 fixed regions for each stream |
| Audio | |
| Audio Compression | G.711,G.722.1,G.726,MP2L2,PCM,MP3,AAC-LC |
| Audio Bit Rate | 64 Kbps (G.711),16 Kbps (G.722.1),16 Kbps (G.726),32 to 192 Kbps (MP2L2),16 to 64Kbps (AAC-LC),8 to 320 Kbps (MP3) |
| Audio Sampling Rate | MP2L2: 16 kHz, 32kHz, 48 kHz,AAC-LC: 16 kHz, 32kHz, 48 kHz,PCM: 8 kHz, 16 kHz, 32kHz, 48 kHz,MP3: 8 kHz, 16 kHz, 32kHz, 48 kHz |
| Environment Noise Filtering | yes |
| Network | |
| Protocols | DHCP,FTP,HTTPS,TCP/IP,ICMP,HTTP,SFTP,DNS,DDNS,RTP,RTSP,RTCP,PPPoE,NTP,UPnP,SMTP,SNMP,IGMP,802.1X,QoS,IPv4/IPv6,UDP,Bonjour,WebSocket,WebSockets |
| Simultaneous Live View | 20 |
| API | ONVIF (Profile S, Profile G, Profile T),ISAPI,SDK,ISUP |
| User/Host | 32 |
| Security | 802.1X authenticated access,MAC address binding,Authenticated username and password,IP address filter,HTTPS encryption |
| Network Storage | NAS (NFS, SMB/CIFS),auto network replenishment (ANR) |
| Client | iVMS-4200,HikCentral Pro,Hik-Connect |
| Web Browser | IE 11, Chrome 80+, Firefox 80+, Safari 13+ |
| Image | |
| Image Parameters Switch | Yes |
| Image Settings | sharpness,saturation,brightness,contrast |
| Day/Night Switch | day, night, auto, scheduled-switch |
| Wide Dynamic Range (WDR) | True WDR |
| SNR | > 52dB |
| Defog | Digital defog |
| Image Stabilization | EIS |
| Image Enhancement | BLC,HLC,3D DNR |

| | |
|-------------------------------|--|
| Privacy Mask | [Bullet channel] 8 programmable polygon privacy masks, [PTZ channel] 24 programmable polygon privacy masks; mask color or mosaic configurable |
| Regional Focus | yes |
| Regional Exposure | yes |
| Interface | |
| Ethernet Interface | RJ45, self-adaptive 10M/100M Ethernet port |
| On-board Storage | Built-in memory card slot, support microSD/microSDHC/microSDXC card, up to 512 GB |
| Audio | 1 audio input, 2.0 to 2.4Vp-p, 1k Ohm±10%, 1 audio output, line level, impedance: 600 Ω |
| Alarm | 1 alarm input, 1 alarm output |
| Reset | yes |
| Built-in Microphone | 2 built-in microphones, picking up sounds in the radius up to 8 m |
| Built-in Speaker | 1 built-in speaker, with effective distance reaching max. 20 m |
| Event | |
| Basic Event | Motion detection, video tampering alarm, exception (network disconnected, IP address conflict, illegal login, HDD full, HDD error), alarm input and output, audio exception detection |
| Smart Event | audio exception detection, region exiting detection, region entrance detection, intrusion detection, Line crossing detection |
| Linkage | red and blue strobe light and audio alarm |
| Deep Learning Function | |
| Face Capture | Detects up to 5 faces simultaneously, Uploads face with background and closed-up face pictures, Supports detecting, tracking, capturing, grading, selecting of face in motion, and outputs the best face picture |
| Regional People Counting | Supports up to 8 detection regions, and independent arming schedule and linkage method. Supports 3 detection modes: people density detection, number of people exception detection, waiting time exception detection |
| Linkage and Tracking | |
| Smart Linkage | manual tracking, linked tracking capture, tracking in turn |
| General | |
| Power | 12 VDC, 3.33 A PoE: IEEE 802.3at, 42.5 to 57.2 V, 0.6 A |
| Dimension | Ø166 mm × 294.8 mm (Ø6.5" × 11.6") |
| Weight | Approx. 3.0 kg (16.5 lb.) |
| Material | ADC12 |
| Operating Condition | -30 °C to 65 °C (-22 °F to 149 °F). Humidity 95% or less (non-condensing) |
| General Function | mirror, password protection, watermark, IP address filter |
| Demist | Demist by heating the glass |
| Approval | |
| Protection | IP67 (IEC 60529-2013), TVS 6000 V lightning protection, surge protection and voltage transient protection |

▪ DORI

The DORI (detect, observe, recognize, identify) distance gives the general idea of the camera ability to distinguish persons or objects within its field of view. It is calculated based on the camera sensor specification and the criteria given by EN 62676-4: 2015.

| DORI | Detect | Observe | Recognize | Identify |
|-----------------|----------------------|---------------------|---------------------|--------------------|
| Definition | 25 px/m | 63 px/m | 125 px/m | 250 px/m |
| Distance (Tele) | 960.0 m (3149.61 ft) | 381.0 m (1250.0 ft) | 192.0 m (629.92 ft) | 96.0 m (314.96 ft) |

▪ **Available Model**

DS-2SE4C425MWG-E/RB/14(F0)

▪ **Dimension**

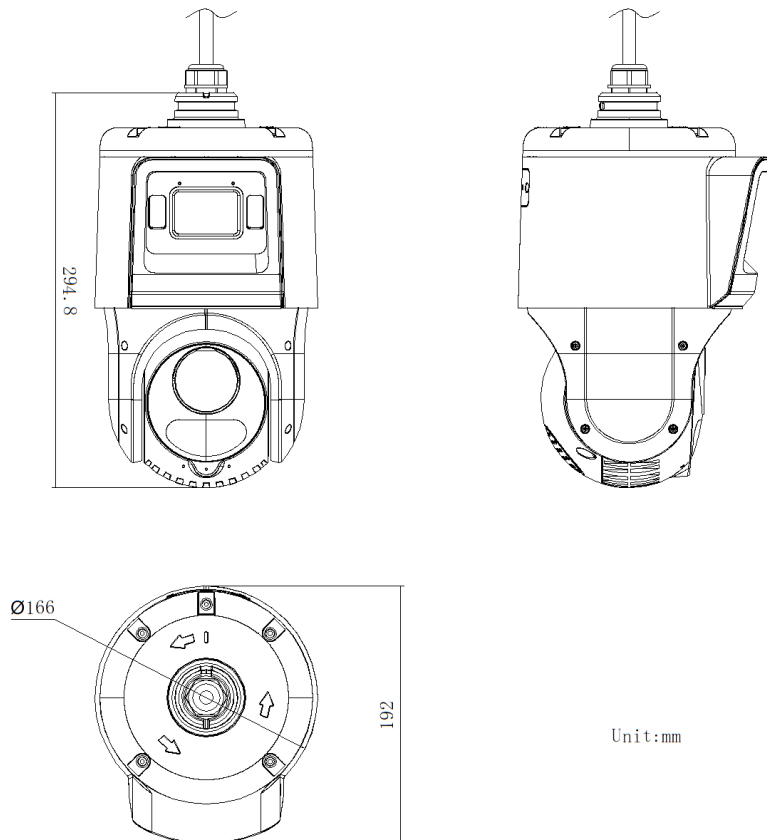





















▪ **Accessory**

▪ **Included**



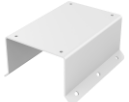







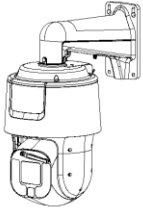
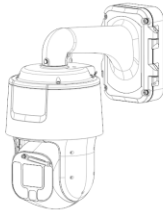
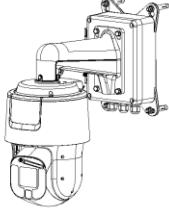
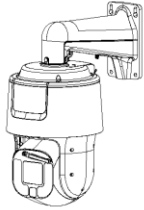
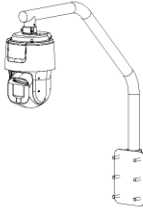
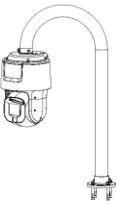

▪ **Optional**

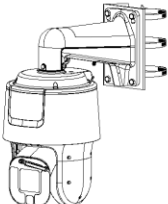
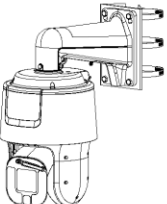
| | | | | |
|-----------|--------------|-----------|------------------------|-----------|
| DS-1660ZJ | DS-4650ZJ-WC | DS-1663ZJ | DS-1604ZJ-BOX-PO LE | DS-1276ZJ |
|-----------|--------------|-----------|------------------------|-----------|

| | | | | |
|---|---|---|---|---|
|  |  |  |  |  |
| DS-1604ZJ | DS-1604ZJ-BOX-CORNER | DS-1674ZJ | DS-1604ZJ-box | DS-1602ZJ |
|  |  |  |  |  |
| DS-1684ZJ | DS-1604ZJ-corner | DS-1619ZJ | DS-1662ZJ | DS-1661ZJ |
|  |  |  |  |  |
| DS-1604ZJ-pole | DS-4660ZJ-WC | DS-1667ZJ | DS-1673ZJ | DS-1673ZJ |
|  |  |  |  |  |
| DS-1673ZJ | | | | |
|  | | | | |

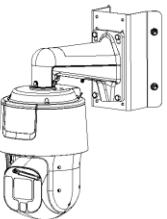
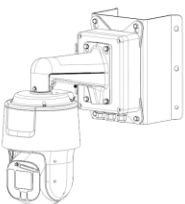
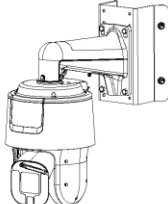
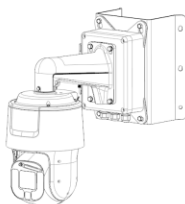
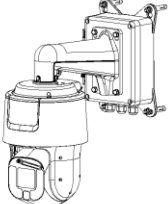
▪ **Installation Methods**

| | | | | |
|--|--|--|--|---|
| Wall Mounting DS-1618ZJ | Wall Mounting DS-1604ZJ | Wall Mounting DS-1604ZJ-box | Wall Mounting DS-1602ZJ | Gooseneck Mounting DS-1660ZJ |
|--|--|--|--|---|

| | | | | |
|---|---|---|---|---|
|  |  |  |  |  |
| Gooseneck Mounting DS-1619ZJ | Vertical Pole Mounting DS-4650ZJ-WC+DS-1602ZJ+DS-1674ZJ | Vertical Pole Mounting DS-1604ZJ-BOX-POLE | Vertical Pole Mounting DS-1684ZJ+DS-1602ZJ | Vertical Pole Mounting DS-1604ZJ-pole |
|  |  |  |  |  |
| Pendant Mounting DS-1663ZJ | Pendant Mounting DS-1662ZJ | Pendant Mounting DS-1661ZJ | Pendant Mounting DS-1667ZJ | Corner Mounting DS-1276ZJ+DS-1602ZJ |
|  |  |  |  |  |
| Corner Mounting DS-1604ZJ-BOX-CORNER | Corner Mounting DS-1604ZJ-corner | Corner Mounting DS-4660ZJ-WC+DS-1602ZJ+DS-1674ZJ | Junction Box DS-1674ZJ+DS-1602ZJ | Horizontal Pole Mounting DS-1673ZJ+DS-1663ZJ |
|  |  |  |  |  |
| Horizontal Pole Mounting DS-1673ZJ+DS-1662ZJ | Horizontal Pole Mounting DS-1673ZJ+DS-1661ZJ | | | |
|  |  | | | |

See Far, Go Further



www.hikvision.com
support@hikvision.com

